

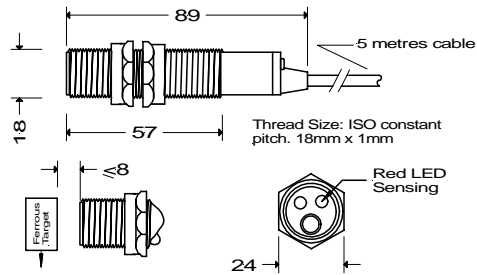

ATEX Approved Proximity Sensor Type: ID/E1MO(A)

Dimensions - mm



Connections:- npn connection

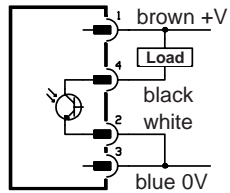

pnp connection

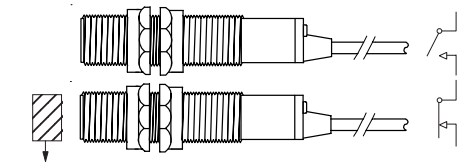
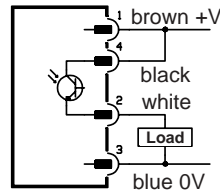

Protection

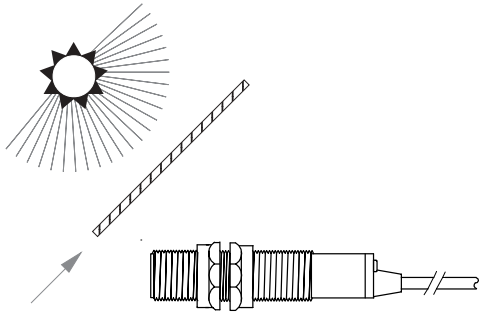

npn connection

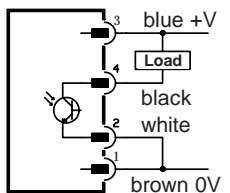

pnp connection

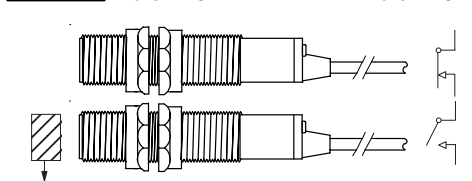
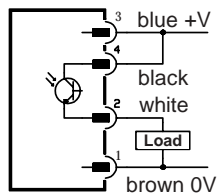

Approval



Approval No:
Baseefa03ATEX0589X

Category:
Ex II 1D T100°C Tamb -15°C to +50°C IP65

Specification

Supply V 10-30V dcc.
Output Opto-isolated
transistor, npn or
pnp use.
Output Rating ... 100 mA 30V dc max.
Max. Speed 200 Hz.

->ID_E1MOATEXMAN 644-050(A)

ATEX Approved Proximity Sensor Type: ID/E1MO(A)

Dimensions - mm

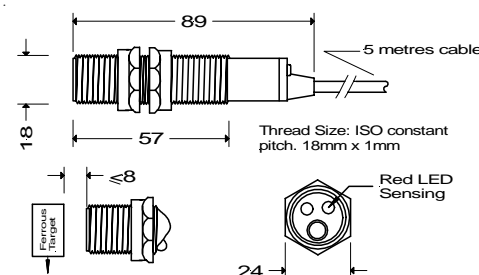

Connections:- npn connection

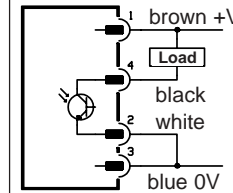

pnp connection

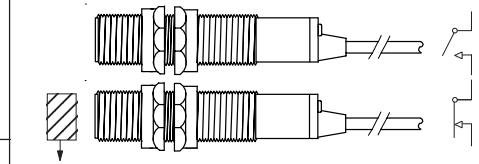
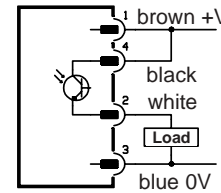

Protection

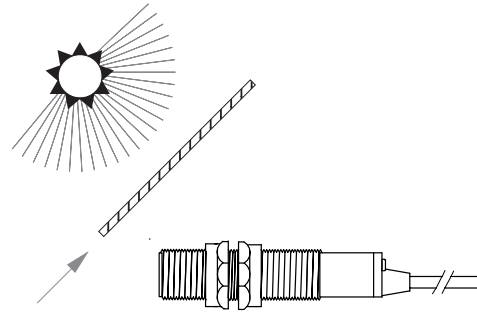

npn connection

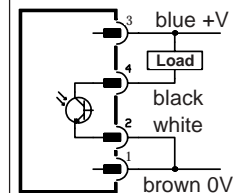

pnp connection

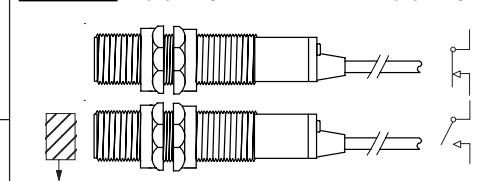
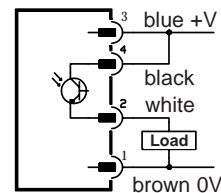

Approval



Approval No:
Baseefa03ATEX0589X

Category:
Ex II 1D T100°C Tamb -15°C to +50°C IP65

Specification

Supply V 10-30V dcc.
Output Opto-isolated
transistor, npn or
pnp use.
Output Rating ... 100 mA 30V dc max.
Max. Speed 200 Hz.

->ID_E1MOATEXMAN 644-050(A)